



athmer.com

# Automatic dropseals

MINI CATALOGUE / 4TH EDITION

**athmer**



GOOD DOORS DESERVE  
FIRST-CLASS SEALS

**GOOD  
CUSTOMERS  
DESERVE  
FIRST-CLASS  
SERVICE**

athmer, based in Arnsberg-Müschede, is the leading international manufacturer of sealing and finger protection systems for doors and gates. Automatic drop seals from athmer comply with the recommendations for barrier-free and sustainable construction.

The seals are mainly used in buildings such as hospitals, office buildings and schools. Special seals for all-glass or sliding doors round off the range. The longevity of the products plays an important role in counteracting the prevailing obsolescence. The owner-managed medium-sized company has more than 60 years of experience in the field of automatic drop seals and is part of the Julius Cronenberg Sophienhammer (JCS) group of companies. In addition to the approximately 100 employees, whose number has risen continuously in recent years, a modern machine park and a constant will to innovate guarantee market success.

The comprehensive range for professional sealing systems for doors and gates is designed for demanding tasks in the construction sector and offers sealing systems for sound, smoke, fire and radiation protection doors.

To guarantee both high product quality and fast delivery times, athmer is represented at a total of six locations in Europe and Asia. Ecological agreements are the basis for good and responsible cooperation. The success of the company is a combination of expertise and quality and enables the continuous development and improvement of its product range. Offering the widest range on the market, athmer has the right product for practically every type of application. In addition to automatic door seals for acoustic, smoke and fire protection doors, the range also includes seals for radiation protection doors, all-glass doors, doors with extreme gaps up to 50 mm, screed separations, thresholds, brush seals, frame seals and finger protection systems.

For athmer, the optimal ease of use of doors has traditionally been at the top of the product development agenda. Today we see that the requirements for barrier-free planning and construction are becoming more and more important. With athmer sealing systems, door manufacturers and builders are on the safe side when it comes to accessibility. This applies to our standard systems as well as to individual solutions that we develop together with our customers.

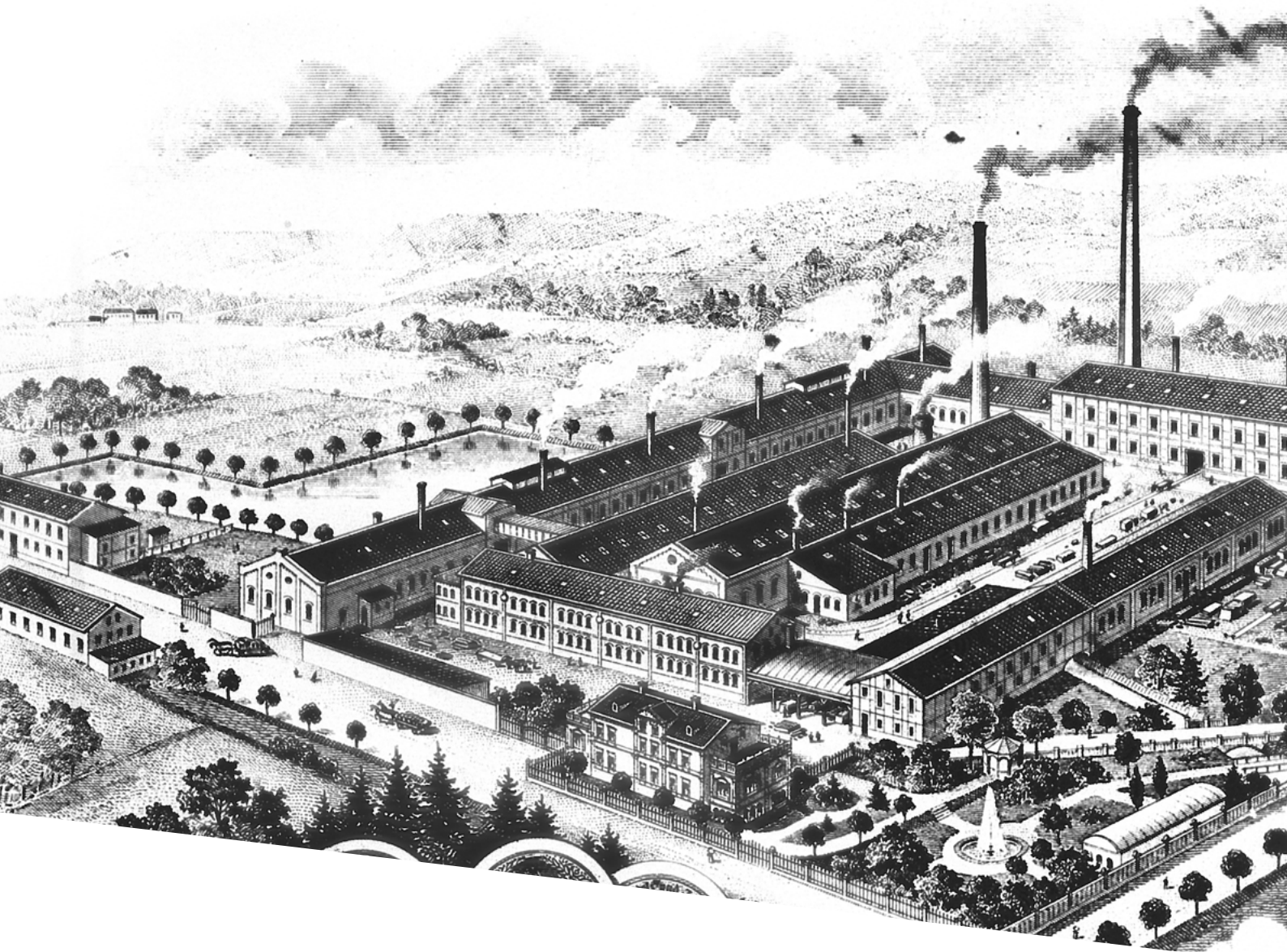

## Responsible and reliable since 1711

athmer has been the leading global specialist in the design and manufacture of high performance sealing and finger protection systems since the 1950's.

From our headquarters in Arnshausen, Germany a continued focus on development and innovation has facilitated our emergence as the premium choice in complete door sealing systems. athmer is part of the JCS (Julius Cronenberg Sophienhammer) group of companies. The group was founded in 1711 and recently celebrated its 300th anniversary. Its headquarters remains on the same site – the old Sophienhammer forge – it purchased in 1870 and its operations have grown sustainably ever since, with the group now incorporating 10 companies.

The family-owned group is now in its 10th generation and first made a name for itself in the late 19th Century

as it developed the first branded scythe, a popular agricultural tool of the period.

The emergence of more modern agricultural techniques in the mid-1950's gave the group an opportunity to diversify into new markets, leading to the registration of the Kaltefeind® brand and the birth of athmer. Today both the Kaltefeind® and Schall-Ex® brands are synonymous with automatic drop seals and athmer has built on this experience by widening its field of expertise to perimeter sealing.

Having made several investments worldwide, we have expanded our operations into the Middle East and throughout South East Asia, including China and India. With a new global presence we hope to offer a more targeted product offering and more personalised service level to the individual regions.

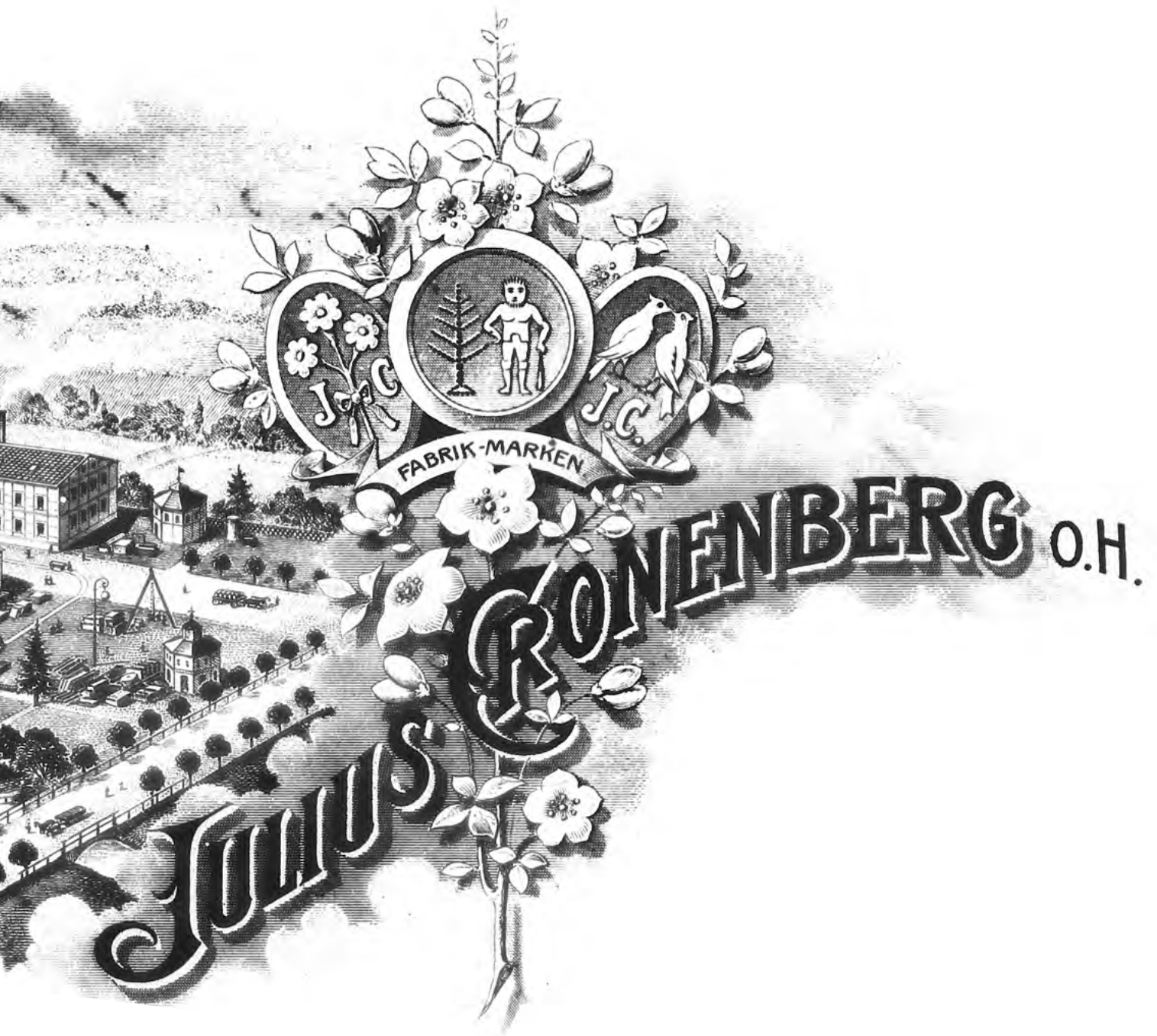

**J C S**

**JULIUS CRONENBERG SOPHIENHAMMER  
OFFENE HANDELSGESELLSCHAFT SEIT 1711**



## Quality Made in Germany

For us, quality is an important component of athmer's success, because we produce durable, reliable and therefore sustainable products. Door seals and finger protection systems must meet the highest standards before they are installed. At the same time, we always have a desire for innovation.

This is one reason why we have over 150 patents and utility models worldwide that optimize seals and finger protection. Before a product leaves our company, it is put through its paces. Because only when it meets our high quality standards it's ready for the market and good enough for our customers.

## Research and development

# Traditions that bind. Innovations that change.

When introducing new products, the research and development process is of crucial importance. A thorough development process ensures a smooth product launch and continuous usability. This is highly relevant in today's world, where innovations must be integrated efficiently and without errors.

Thanks to modern technology and the necessary know-how, a whole range of development processes can be carried out in-house. These include 3D modeling, 3D printing and pre-testing of various materials. The key to our success is our ability to adapt to an ever-changing market, which has established us as pioneers in sealing technology.

# Our commitment quality & sustainability

Athmer is committed to both quality and sustainability and this has been **internationally recognised** by test and certification institutes worldwide. Copies of all certification can be supplied on request.



Wherever you see this logo our products have been evaluated under Warringtonfire's CERTIFIRE scheme. CERTIFIRE is an internationally-recognised, independent third-party certification scheme that assures performance, quality, reliability and traceability of products and systems.



Wherever you see this logo our products have been evaluated under the UL Mark – the most widely recognised and accepted evidence of a product's compliance with U.S. & Canadian safety requirements. The mark is one of the most valued product safety symbols worldwide, including Asia & the Middle East.



Wherever you see this logo our products have been cycle tested by MPA NRW in Germany. MPA NRW is a publically-owned test institute that was founded in 1947 and they have provided us with independent testing as evidence of our seal's durability. MPA's independent verification is another example of our commitment to quality and it supports the extensive and frequent internal testing we conduct on our products.



Wherever you see this logo our products are covered by an Environmental Product Declaration (EPD) in accordance with EN ISO 14025 and EN 15804. The EPD is further evidence of our wider commitment to sustainability and permits our product's use in certified Green Buildings across the world. Additionally, we have developed a CO<sup>2</sup> calculator to help users understand the tangible environmental benefits of fitting Athmer seals to their buildings. You can access it via [co2ool.info](http://co2ool.info).



## Content

CHAPTER	CATEGORY	PAGE
<b>1.0</b>	<b>Drop seals</b>	
1.1	/ rebated drop seals for hinged timber doors	10
1.2	/ rebated drop seals for hinged metal doors	20
1.3	/ drop seals for hinged glass doors	32
1.4	/ drop seals for sliding timber, metal & glass doors & for pivot doors	36
1.5	/ surface mounted drop seals for hinged timber & metal doors	46
<b>2.0</b>	<b>Flush bolts for drop seals</b>	54
<b>3.0</b>	<b>Threshold plates</b>	56
<b>4.0</b>	<b>Indices &amp; information</b>	
4.1	/ cross section drawings	61
4.2	/ installation information	64
4.3	/ glossary of terms	65
4.4	/ product index	70

Rebated drop seals  
for hinged timber doors

# Classic solutions for everyday doors

Our range of rebated drop seals for timber doors is already well-established in the industry following **decades of assured quality** and consistent innovation. This type of drop seal is fitted into a grooved rebate in the bottom of timber doors, remaining hidden during daily use. As a result, door designers can meet performance requirements whilst maintaining the door's aesthetic quality regardless of the chosen material, style and finish.

The seal drops automatically when the door is closed to form a seal with the floor, retracting when the door is opened to ensure the door operation is unhindered. This section contains options for use with both hinged and pivoted timber doors. Their main purpose is to provide an **effective barrier against sound** transfer at the door threshold, as well as smoke, air, light, dirt, dust, insects and odours. We have tested options for specialist applications including protection from radiation, corrosion and weather elements such as wind and driving rain.



**Rebated drop seals**  
for hinged timber doors

## NEW GENERATION

/ The latest generation introduces an industry-wide benchmark with regard to quality and performance for timber doors

## UNCOMPROMISED ACOUSTIC PERFORMANCE

/ Designed with the latest technology to reduce sound flanking and achieve the highest performance over a range of gaps

# SCHALL-EX<sup>®</sup> L-15

THE CLASSIC  
TIMBER  
DOOR SEAL

## **CERTIFIED QUALITY**

- / Testing and auditing from world-leading third-party certification schemes provide confidence in L-15's product quality and consistency

## **DURABILITY YOU CAN DEPEND ON**

- / L-15's host of new features including parallel drop protect the seal and door frame from damage and reduce sealing friction

## **FLUSH BOLT INTEGRATION**

- / Schall-Ex® L-15 can be integrated with a flush bolt, maintaining optimal acoustic performance on double doors



## Schall-Ex® L-15/30

- / the classic timber door drop seal
- / parallel drop minimises friction with the floor
- / tool free actuator can be deactivated before building occupancy
- / actuator requires no protective press plate for the frame
- / no lateral travel during actuation enhances gasket position



### DIMENSIONS

	Schall-Ex® L-15/30 WS	Schall-Ex® L-15/30 OS
Groove width	15 mm	15 mm
Travel	20 mm	20 mm

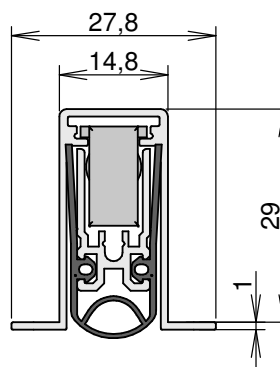
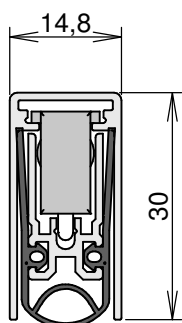

### TECHNICAL DATA

Application	hinged timber doors	
Actuation	single	
Material	self-extinguishing, flame retardant silicone	
Fixing	rebated into a groove in the door, screw fixed both sides with fixing brackets	rebated into a groove in the door, screw fixed to the underside
Performance	Fire: EN 1634-1*, UL10B & UL10C (R31866) Smoke: Certifire TS21 (CF 5675) Acoustic: 52dB over 7 mm gap, 51dB over 12 mm gap	
Standard lengths	708, 833, 958, 1,083, 1,208 mm (can be shortened: 125 mm)	
Min/max lengths	235 mm / 2,000 mm	235 mm / 2,335 mm
Accessories	5382	-
Art.No.	1-880	1-881

\*The test value may differ according to the EN 1634-1 test, as the complete door system must be checked.

## Schall-Ex® L-8/30 WS

- / narrowest seal for the second sealing level
- / parallel drop minimises friction with the floor
- / no misalignment of the inner rail
- / inner rail can be removed
- / no lateral travel during actuation enhances gasket position
- / tool free actuator can be deactivated before building occupancy



### DIMENSIONS

Groove width	8 mm
Travel	20 mm

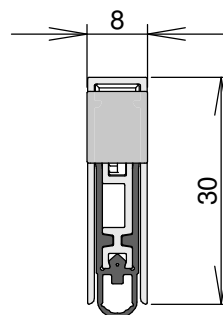

### TECHNICAL DATA

Application	hinged timber doors
Actuation	single
Material	self-extinguishing, flame retardant silicone
Fixing	rebated into a groove in the door, screw fixed both sides with fixing brackets
Standard lengths	708, 833, 958, 1,083, 1,208 mm (can be shortened: 125 mm)
Min/max lengths	235 mm / 2,000 mm
Accessories	5820
Art.No.	1-1000



## Schall-Ex® L-14/35 EK

- / drop seal with common groove dimension
- / end plates provide neat finish
- / parallel drop minimises friction with the floor
- / tool free actuator can be deactivated before building occupancy
- / actuator requires no protective press plate for the frame



### DIMENSIONS

Groove width	14 mm
Travel	20 mm

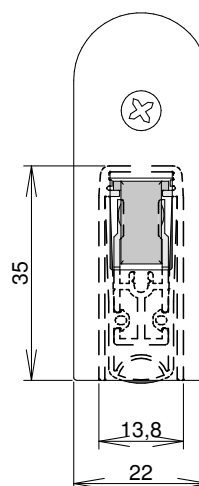

### TECHNICAL DATA

Application	hinged timber doors
Actuation	single
Material	self-extinguishing, flame retardant silicone
Fixing	rebated into a groove in the door, fixed with end plates on both sides
Performance	Fire: EN 1634-1*, UL10B & UL10C (R31866) Smoke: Certifire TS21 (CF 5675) Acoustic: 51dB over 7 mm gap, 44dB over 12 mm gap
Standard lengths	635, 735, 835, 935, 1,035, 1,135, 1,235 mm (can be shortened: min 100 mm)
Min/max lengths	235 mm / 1,635 mm
Accessories	5519
Art.No.	1-935

\*The test value may differ according to the EN 1634-1 test, as the complete door system must be checked.

## Schall-Ex® Ultra

- / corrosion-resistant drop seal
- / salt spray tested to EN 1670, Class 5 (480 hours)
- / ideal for use in high humidity environments
- / overload protection protects seal from excessive wear
- / also available with double actuation



### DIMENSIONS

	Schall-Ex® Ultra WS	Schall-Ex® Ultra OS
Groove width	20 mm	20 mm
Travel	12 mm	12 mm

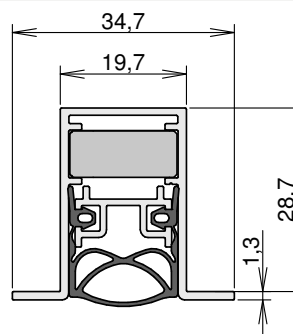
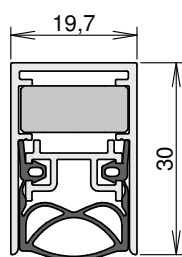

### TECHNICAL DATA

Application	hinged timber doors	
Actuation	single	
Material	self-extinguishing, flame retardant silicone	
Fixing	rebated into a groove in the door, screw fixed both sides with fixing brackets	rebated into a groove in the door, screw fixed to the underside
Performance	Fire: UL10B & UL10C (R31866) Smoke: Certifire TS21 (CF 5675) Acoustic: 51dB over 7 mm gap	
Standard lengths	708, 833, 958, 1,083, 1,208 mm (can be shortened: 125 mm)	
Min/max lengths	220 mm / 2,000 mm	
Accessories	5610	5503
Art.No.	1-291 available as double actuation: 1-290 (technical data may differ)	1-293 available as double actuation: 1-292 (technical data may differ)

## Rainstop® L-24/20 WS

- / weatherproof drop seal
- / air permeability tested (EN 12207, class 4)
- / watertightness (EN 12208, class 7a)



### DIMENSIONS

Groove width	24 mm
Travel	16 mm

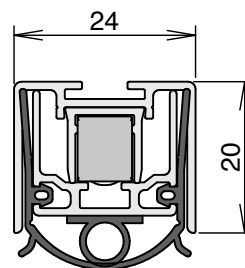

### TECHNICAL DATA

Application	hinged timber doors
Actuation	single
Material	self-extinguishing, flame retardant silicone
Fixing	rebated into a groove in the door, screw fixed both sides with fixing brackets
Performance	Fire: UL10C (R31866) Acoustic: 54dB over 7 mm gap
Standard lengths	750, 900, 1,050, 1,200, 1,250 mm (can be shortened: 150 mm)
Min/max lengths	230 mm / 2,000 mm
Accessories	5475
Art.No.	1-955

Rebated drop seals  
for hinged metal doors

# Modular solutions for practical doors

Our range of rebated drop seals for metal doors has been designed to overcome the technical challenges faced by system door manufacturers and designers. This type of drop seal is fitted into a rebate in the bottom of system doors, remaining hidden during daily use. Modular components and a larger range of sizes **provides more flexibility** where space has already been predetermined.

The seal drops automatically when the door is closed to form a seal with the floor, retracting when the door is opened to ensure the door operation is unhindered. Their main purpose is to provide an effective barrier against sound transfer at the door threshold, as well as smoke, air, light, dirt, dust, insects and odours. We have tested options for **specialist applications** including protection from corrosion and weather elements such as wind and driving rain.

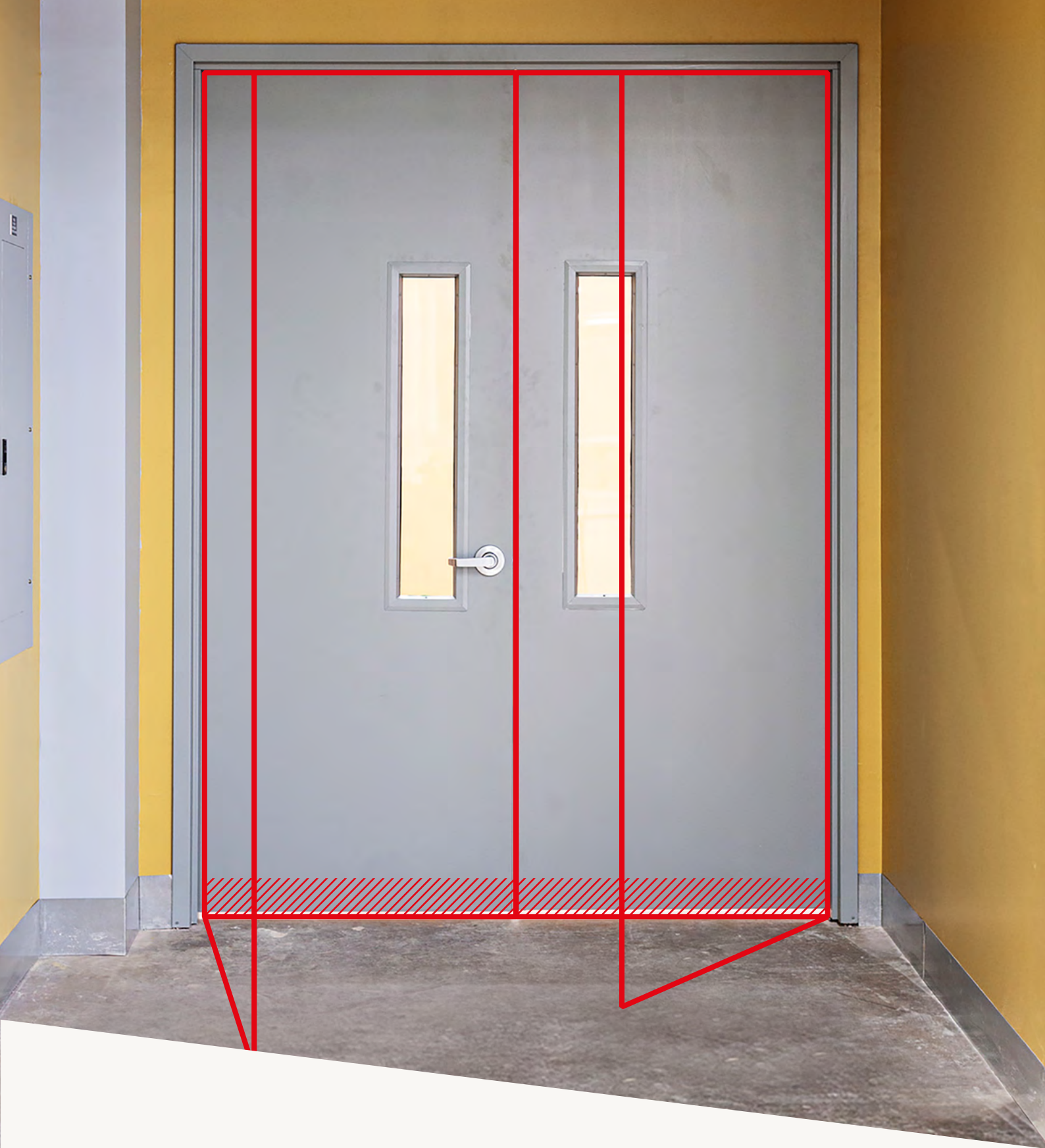

**Rebated drop seals**  
for hinged metal doors

## **MODULAR COMPONENTS FOR GREATER FLEXIBILITY**

- / Wide range of sizes and fixing variations based on the same mechanical philosophy for more flexibility in predetermined spaces

## **SUITABLE FOR ALL MATERIAL TYPES**

- / Suitable for system doors made from various types of material - including PVC, steel and aluminium

# STADI

## THE MODULAR SYSTEM DOOR SEAL



### QUALITY YOU CAN DEPEND ON

- / Confidence in Stadi's product quality and consistency is provided by testing and auditing from world-leading third-party certification schemes

### IMPROVED DURABILITY

- / Stadi's host of new features including overload protection protect the seal and door frame from damage and reduce sealing friction

### FLUSH BOLT INTEGRATION

- / All size options can be integrated with a flush bolt, maintaining optimum acoustic performance on double doors

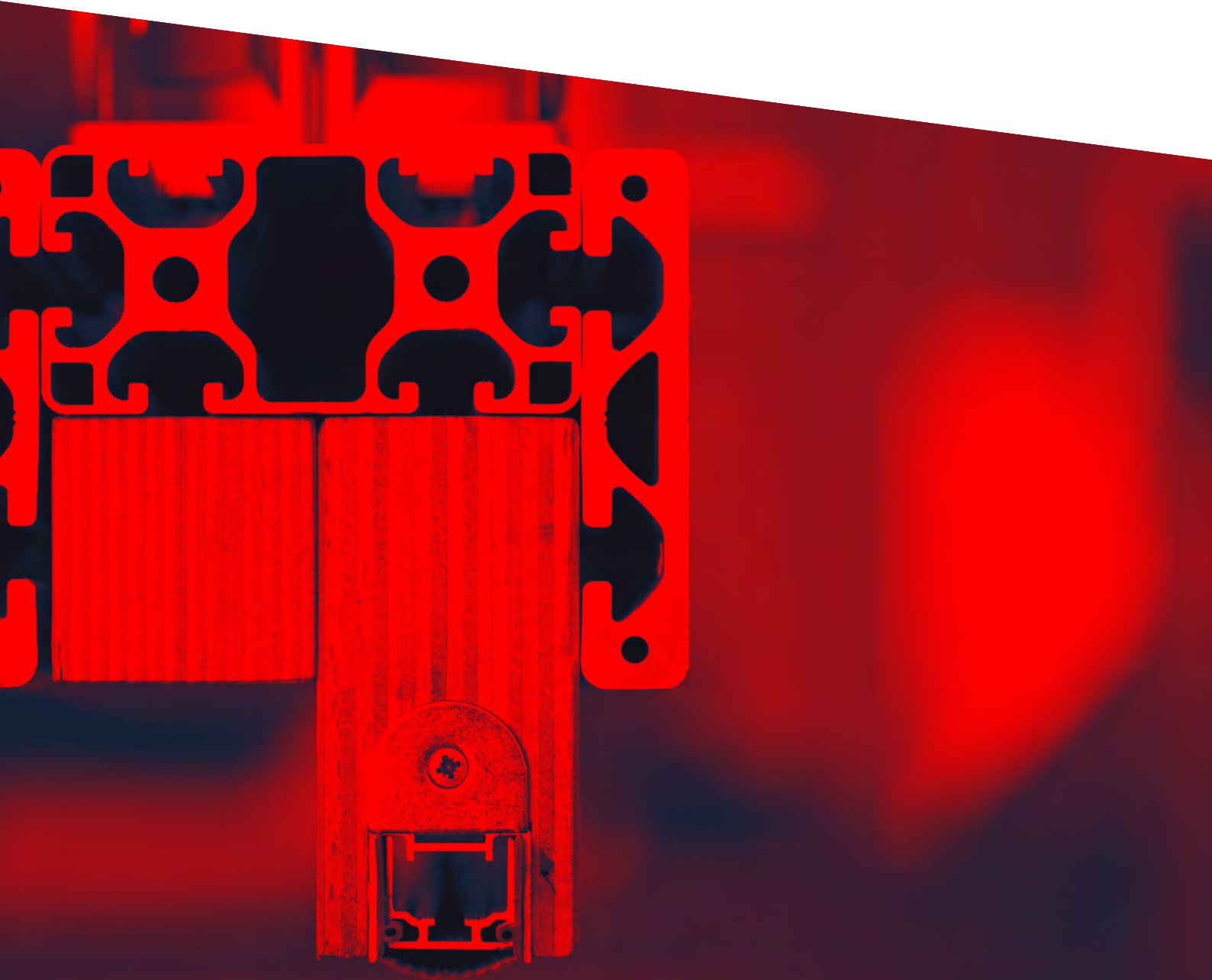

## Stadi M-17/17 WS

## Stadi MD-17/17 WS

- / the modular system door seal
- / parallel drop minimises friction
- / tool-free actuator can be deactivated before building occupancy
- / overload protection protects seal from excessive wear
- / MD: delay mechanism, ideal for airlock and positive-pressure rooms

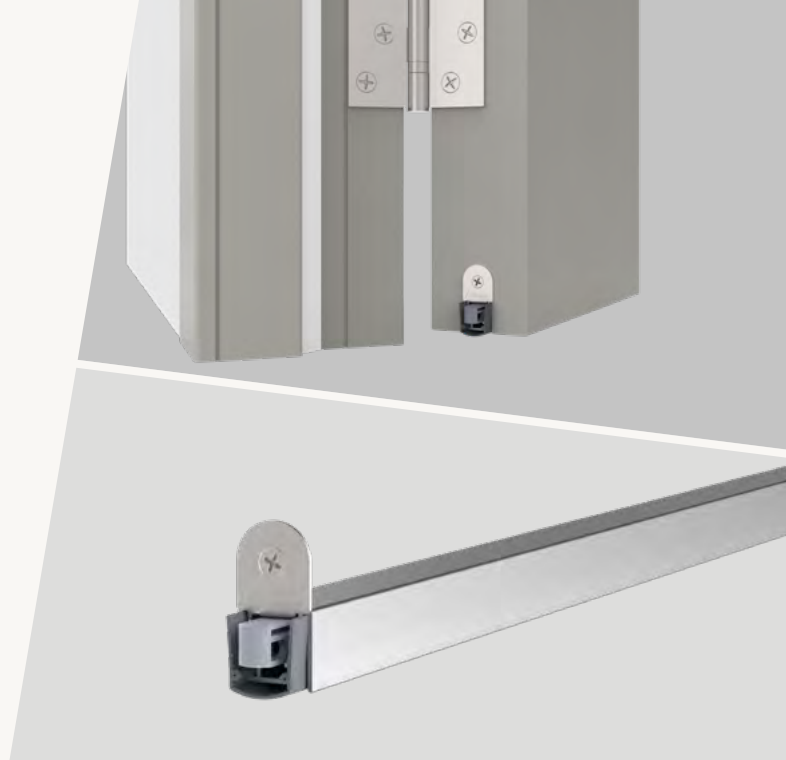

### DIMENSIONS

Groove width	17 mm
Travel	13 mm

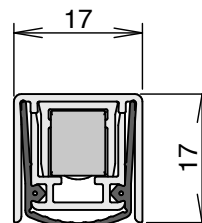

### TECHNICAL DATA

	Stadi M -17/17 WS	Stadi MD-17/17 WS
Application	hinged system doors	
Actuation	single	single, with delayed drop
Material	self-extinguishing, flame retardant silicone	
Fixing	rebated into a groove in the door, screw fixed both sides with fixing brackets	
Performance	Fire: UL10B & UL10C (R31866) Acoustic: 52dB over 12 mm gap	
Standard lengths	750, 900, 1,050, 1,200 mm (can be shortened: 150 mm)	
Min/max lengths	250 mm / 2,000 mm	655 mm / 2,000 mm
Accessories	5104	5428
Art.No.	1-937	1-950

## Stadi L-17/20 WS

## Stadi LD-17/20 WS

- / the modular system door seal
- / parallel drop minimises friction
- / tool-free actuator can be deactivated before building occupancy
- / overload protection protects seal from excessive wear
- / LD: delay mechanism, ideal for airlock and positive-pressure rooms



### DIMENSIONS

Groove width	17 mm
Travel	16 mm

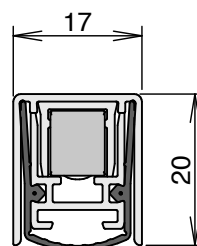

### TECHNICAL DATA

	Stadi L -17/20 WS	Stadi LD-17/20 WS
Application	hinged system doors	
Actuation	single	single, with delayed drop
Material	self-extinguishing, flame retardant silicone	
Fixing	rebated into a groove in the door, screw fixed both sides with fixing brackets	
Performance	Fire: UL10B & UL10C (R31866) Smoke: Certifire TS21 (CF 5675) Acoustic: 52dB over 7 mm gap, 51dB over 12 mm gap	
Standard lengths	750, 900, 1,050, 1,200 mm (can be shortened: 150 mm)	
Min/max lengths	250 mm / 2,000 mm	655 mm / 2,000 mm
Accessories	5104	5428
Art.No.	1-940	1-953

# Stadi L-20/20 WS

## Stadi LD-20/20 WS

- / the modular system door seal
- / parallel drop minimises friction
- / tool-free actuator can be deactivated before building occupancy
- / overload protection protects seal from excessive wear
- / LD: delay mechanism, ideal for airlock and positive-pressure rooms



### DIMENSIONS

Groove width	20 mm
Travel	16 mm

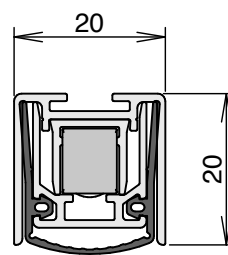

### TECHNICAL DATA

	Stadi L-20/20 WS	Stadi LD-20/20 WS
Application	hinged system doors	
Actuation	single	single, with delayed drop
Material	self-extinguishing, flame retardant silicone	
Fixing	rebated into a groove in the door, screw fixed both sides with fixing brackets	
Performance	Fire: UL10B & UL10C (R31866) Smoke: Certifire TS21 (CF 5675) Acoustic: 52dB over 12 mm gap	
Standard lengths	750, 900, 1,050, 1,200 mm (can be shortened: 150 mm)	
Min/max lengths	230 mm / 2,000 mm	635 mm / 1,600 mm
Accessories	5104	5428
Art.No.	1-939	1-952

# Stadi L-20/20 OS

# Stadi LD-20/20 OS

- / the modular system door seal
- / parallel drop minimises friction
- / tool-free actuator can be deactivated before building occupancy
- / overload protection protects seal from excessive wear
- / LD: delay mechanism, ideal for airlock and positive-pressure rooms



## DIMENSIONS

Groove width	20 mm
Travel	16 mm

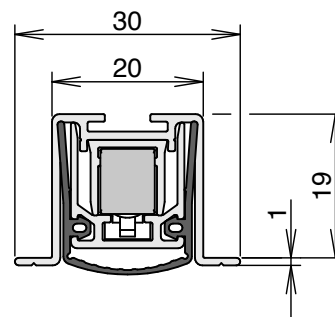

## TECHNICAL DATA

	Stadi L -20/20 OS	Stadi LD-20/20 OS
Application	hinged system doors	
Actuation	single	single, with delayed drop
Material	self-extinguishing, flame retardant silicone	
Fixing	rebated into a groove in the door, screw fixed to the underside	
Performance	Smoke: Certifire TS21 (CF 5675) Acoustic: 52dB over 12 mm gap	Acoustic: 52dB over 12 mm gap
Standard lengths	750, 900, 1,050, 1,200 mm (can be shortened: 150 mm)	
Min/max lengths	230 mm / 2,000 mm	635 mm / 1,600 mm
Accessories	5503	
Art.No.	1-972	1-985

1.0 Drop seals  
1.2 rebated drop seals for hinged metal doors

# Stadi L-24/20 WS

## Stadi LD-24/20 WS

- / the modular system door seal
- / parallel drop minimises friction
- / tool-free actuator can be deactivated before building occupancy
- / overload protection protects seal from excessive wear
- / LD: delay mechanism, ideal for airlock and positive-pressure rooms



### DIMENSIONS

Groove width	24 mm
Travel	16 mm

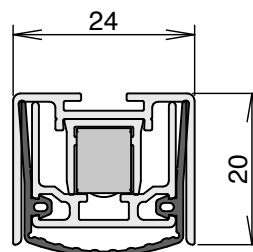

### TECHNICAL DATA

#### Stadi L-24/20 WS

#### Stadi LD-24/20 WS

Application	hinged system doors	
Actuation	single	single, with delayed drop
Material	self-extinguishing, flame retardant silicone	
Fixing	rebated into a groove in the door, screw fixed both sides	
Performance	Fire: UL10B & UL10C (R31866) Smoke: Certifire TS21 (CF 5675) Acoustic: 54dB over 7 mm gap, 51dB over 12 mm gap	
Standard lengths	750, 900, 1,050, 1,200 mm (can be shortened: 150 mm)	
Min/max lengths	230 mm / 2,000 mm	635 mm / 1,600 mm
Accessories	5302	5427
Art.No.	1-938	1-951

# Stadi L-24/20 OS

## Stadi LD-24/20 OS

- / the modular system door seal
- / parallel drop minimises friction
- / tool-free actuator can be deactivated before building occupancy
- / overload protection protects seal from excessive wear
- / LD: delay mechanism, ideal for airlock and positive-pressure rooms



### DIMENSIONS

Groove width	24 mm
Travel	16 mm

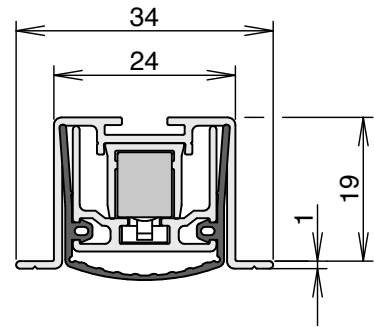

TECHNICAL DATA	Stadi L -24/20 OS	Stadi LD-24/20 OS
Application	hinged system doors	
Actuation	single	single, with delayed drop
Material	self-extinguishing, flame retardant silicone	
Fixing	rebated into a groove in the door, screw fixed to the underside	
Performance	Fire: UL10B & UL10C (R31866) Smoke: Certifire TS21 (CF 5675) Acoustic: 54dB over 7 mm gap, 51dB over 12 mm gap	Acoustic: 54dB over 7 mm gap, 51dB over 12 mm gap
Standard lengths	750, 900, 1,050, 1,200 mm (can be shortened: 150 mm)	
Min/max lengths	230 mm / 3,000 mm	
Accessories	5503	
Art.No.	1-959	1-1025

**1.0 Drop seals**  
 1.2 rebated drop seals for hinged metal doors

# Stadi L-24/20 TS

## Stadi LD-24/20 TS

- / the modular system door seal
- / parallel drop minimises friction
- / tool-free actuator can be deactivated before building occupancy
- / overload protection protects seal from excessive wear
- / LD: delay mechanism, ideal for airlock and positive-pressure rooms



### DIMENSIONS

Groove width	38 mm
Travel	16 mm

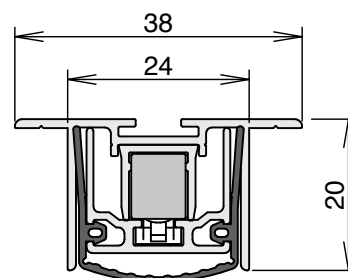

### TECHNICAL DATA

	Stadi L-24/20 TS	Stadi LD-24/20 TS
Application	hinged system doors	
Actuation	single	single, with delayed drop
Material	self-extinguishing, flame retardant silicone	
Fixing	rebated into a groove in the door, screw fixed to the underside	
Performance	Fire: UL10B & UL10C (R31866) Acoustic: 54dB over 7 mm gap, 51dB over 12 mm gap	Acoustic: 54dB over 7mm gap, 51dB over 12mm gap
Standard lengths	750, 900, 1,050, 1,200 mm (can be shortened: 150 mm)	
Min/max lengths	230 mm / 3,000 mm	
Accessories	5503	
Art.No.	1-960	1-1026



Drop seals  
for hinged glass doors

# Elegant solutions for stylish doors

Our range of drop seals for glass doors has been developed with an **emphasis on the strict aesthetic requirements** demanded by frameless glass construction and with the idea to reduce the seal's visual impact as much as possible. Slimline profiles and clever design traits allow the products to blend seamlessly with the door and its hardware whilst achieving the necessary performance.

The seal drops automatically when the door is closed to form a seal with the floor, retracting when the door is opened to ensure the **door operation is unhindered**. Our range can achieve this with a range of glass thicknesses starting from 6mm. Their main purpose is to provide an effective barrier against sound transfer at the door threshold, as well as smoke, air, light, dirt, dust, insects and odours.



**Drop seals**  
for hinged glass doors

# Schall-Ex® GS-H8/12

/ architectural glass door drop seal



## DIMENSIONS

Glass thickness	8-12 mm
Travel	12 mm

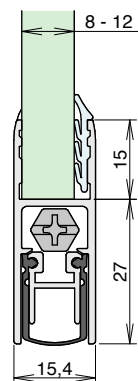

## TECHNICAL DATA

Application	hinged glass doors
Actuation	single
Material	self-extinguishing, flame retardant silicone
Fixing	bonded to underside with builder's adhesive (not supplied)
Performance	Acoustic: 40dB over 10 mm gap
Standard lengths	708, 833, 958, 1,083, 1,208 mm (can be shortened: 125 mm)
Min/max lengths	235 mm / 1,333 mm
Accessories	5550

## COLOURS/ART.NO.

Silver-coloured, anod. (C-0)	1-817
Stainless steel-colored (C-31)	1-818

# Schall-Ex® GS-A

- / retrofit glass door drop seal
- / suitable for new and existing doors with 6mm glass & thicker



## DIMENSIONS

Glass thickness	min. 6 mm
Travel	11 mm

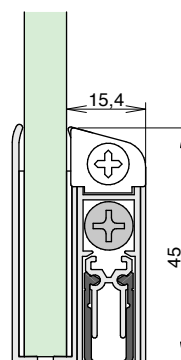

## TECHNICAL DATA

Application	hinged glass doors
Actuation	single
Material	self-extinguishing, flame retardant silicone
Fixing	surface-mounted to door, self-adhesive
Performance	Acoustic: 41dB over 7 mm gap, 37dB over 10 mm gap
Standard lengths	708, 833, 958, 1,083, 1,208 mm (can be shortened: 125 mm)
Min/max lengths	235 mm / 1,333 mm
Accessories	5503

## COLOURS/ART.NO.

Silver-coloured, anod. (C-0)	1-814
Stainless steel-colored (C-31)	1-815

Drop seals  
for sliding timber, metal & glass doors

# Smart solutions for space-efficient doors

Our range of sliding door drop seals has been designed with the specific requirements of sliding doors in mind. **Unique design features** like a flat-faced actuator and a low-pressure mechanism are better suited to the door's closing movement, maintaining low door operating forces and supporting long-term durability. There are options for both latched and unlatched sliding doors, with unlatched door options consisting of an integrated magnet for keeping the door closed and sealed. We also supply complete sliding door solutions, including an innovative four-sided seal for comprehensive performance.

The seal drops automatically when the door is closed to **form a seal with the floor**, retracting when the door is opened to ensure the door operation is unhindered. This section covers sliding door solutions for timber, system and glass door leaf materials. Their main purpose is to provide an effective barrier against sound transfer at the door threshold, as well as smoke, air, light, dirt, dust, insects and odours.



## **Drop seals**

for sliding timber, metal & glass doors  
& for pivot doors

## Pivot L-15 (set)

- / complete four-sided pivot hinge door solution
- / suitable with double-acting doors
- / ground-breaking roller actuator suitable for various frame designs
- / set includes additional frame actuation roller for fitting to scalloped frames
- / supplied with magnetic seals for the vertical edges of door



DIMENSIONS	Schall-Ex® L-15/30 Pivot	Slide magnet
Travel	12 mm	
Gap size		6 mm

TECHNICAL DATA	Schall-Ex® L-15/30 Pivot	Slide magnet
Actuation	single	-
Material	self-extinguishing, flame retardant silicone	aluminium, silicone
Fixing	surface-mounted top and bottom	two part system surface-mounted to frame and door
Standard lengths	833, 958, 1,083, 1,208 mm (can be shortened 125 mm)	2,500 / 3,000 mm
Min/max lengths	235 mm / 2,000 mm	- / 3,000 mm
Accessories	5817	-

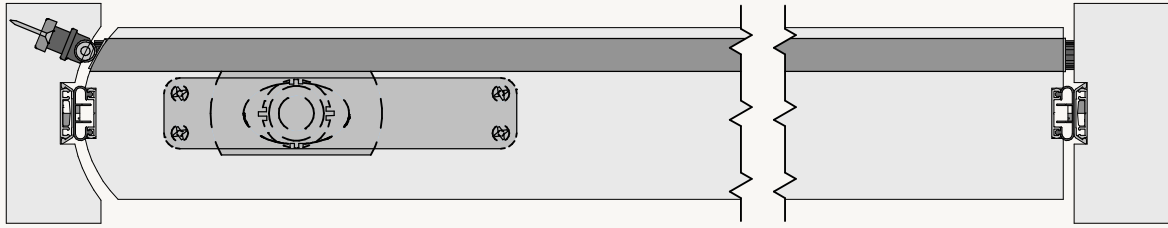

### SET COMPONENTS

/ Schall-Ex® L-15/30 WS Pivot (incl. roller actuator for frame)[2 pcs.]

/ Slide magnet [2 pc.]

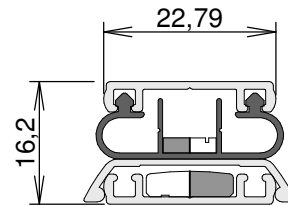
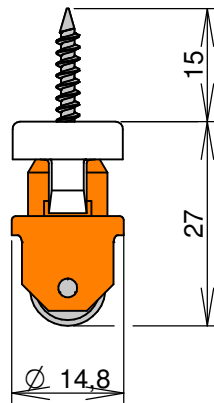
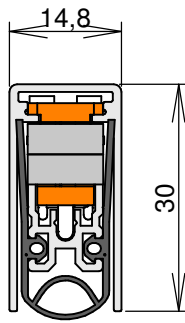

COLOURS/ART.NO.	Lengths slide magnet	
	2,500 mm	3,000 mm
Silver-colored, anod. [C-0]	1-1027	1-1028
Stainless steel-colored [C-31]	1-1029	1-1030

## VHH M-12 (set)

- / top and bottom drop seal set for sliding doors
- / additional adaptor supplied for top of door
- / can be fitted to pocket & wall-mounted doors
- / can be fitted to most roller systems utilising an M8 bolt connection
- / magnet supplied for use with unlatched doors
- / combine with ZD Slide 12/12 vertical seal (optional)



### DIMENSIONS

Groove width	12 mm
Travel	11 mm

### TECHNICAL DATA

#### Schall-Ex® Slide M-12 SLA

Application	sliding timber doors
Actuation	single
Material	self-extinguishing, flame retardant silicone
Fixing	Bottom: rebated into a groove in the door, screw fixed both sides Top: screw fixed with an adaptor
Standard lengths	708, 833, 958, 1,083, 1,208 mm (can be shortened: 125 mm)
Min/max lengths	280 mm / 1,958 mm
Accessories	5106
Art.No.	1-839

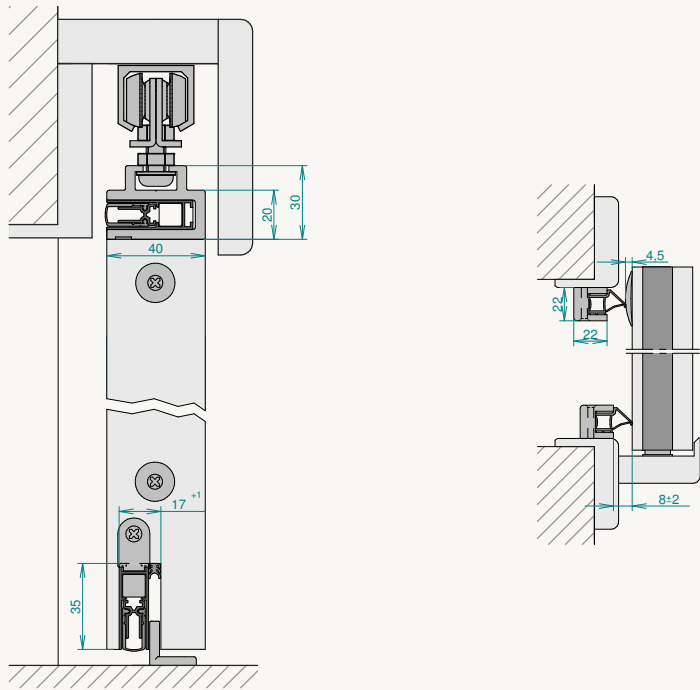

**SET COMPONENTS**

/ Schall-Ex® Slide M-12 SLA [2 pcs.]

/ Slide adapter 12 [1 pc.]

/ M8 bolt and fixings [2 pcs.]

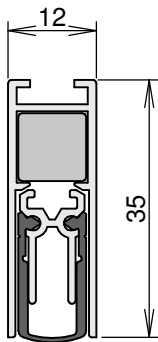

/ door guide [1 pc.]

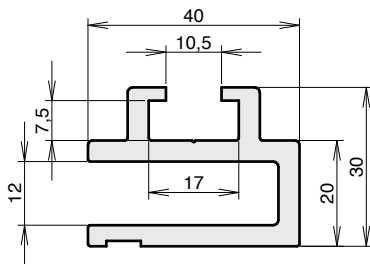

/ magnet [2 pcs.]



/ slide spacer [1 pc.]



## Schall-Ex® Slide M-12 WS

- / latched sliding door drop seal
- / flat-faced actuator with low activation pressure
- / combine with ZD Slide 12/12 vertical seal [optional]



### DIMENSIONS

Groove width	12 mm
Travel	11 mm

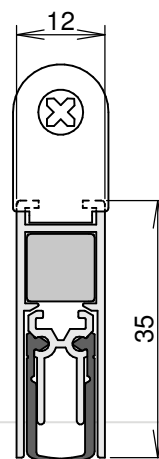

### TECHNICAL DATA

Application	sliding timber doors
Actuation	single
Material	self-extinguishing, flame retardant silicone
Fixing	rebated into a groove in the door, screw fixed both sides with fixing brackets
Performance	Acoustic: 49dB over 7 mm gap, 46dB over 10 mm gap
Standard lengths	708, 833, 958, 1,083, 1,208 mm [can be shortened: 125 mm]
Min/max lengths	280 mm / 1,958 mm
Accessories	5513
Art.No.	1-548

## Schall-Ex® Slide & Lock M-12 WS

- / unlatched sliding door drop seal
- / flat-faced actuator with low activation pressure
- / integrated magnet for doors without latch or lock
- / combine with ZD Slide 12/12 vertical seal [optional]



### DIMENSIONS

Groove width	12 mm
Travel	11 mm

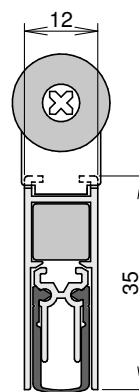

### TECHNICAL DATA

Application	sliding timber doors
Actuation	single
Material	self-extinguishing, flame retardant silicone
Fixing	rebated into a groove in the door, screw fixed both sides with fixing brackets
Performance	Acoustic: 49dB over 7 mm gap, 46dB over 10 mm gap
Standard lengths	708, 833, 958, 1,083, 1,208 mm [can be shortened: 125 mm]
Min/max lengths	280 mm / 1,958 mm
Accessories	5105
Art.No.	1-549

# Schall-Ex® Slide & Lock M-20 WS

- / unlatched sliding door drop seal
- / flat-faced actuator with low activation pressure
- / integrated magnet for doors without latch or lock
- / combine with ZD Slide 12/12 vertical seal (optional)



## DIMENSIONS

Groove width	20 mm
Travel	12 mm

## TECHNICAL DATA

Application	sliding timber doors
Actuation	single
Material	self-extinguishing, flame retardant silicone
Fixing	rebated into a groove in the door, screw fixed both sides with fixing brackets
Performance	Acoustic: 49dB over 7 mm gap, 46dB over 10 mm gap
Standard lengths	708, 833, 958, 1,083, 1,208 mm (can be shortened: 125 mm)
Min/max lengths	220 mm / 2,000 mm
Accessories	5103
Art.No.	1-550

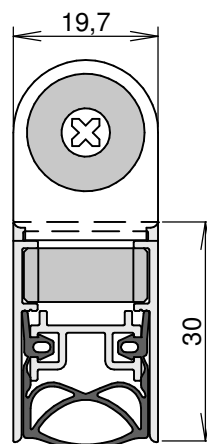

## Schall-Ex® Slide GS-A

- / retrofit sliding glass door drop seal
- / flat-faced actuator with low activation pressure



### DIMENSIONS

Glass thickness	min. 6 mm
Travel	11 mm

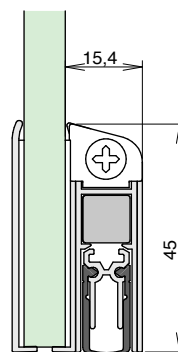

### TECHNICAL DATA

Application	sliding glass doors
Actuation	single
Material	self-extinguishing, flame retardant silicone
Fixing	surface-mounted to door, self-adhesive
Performance	Acoustic: 41dB over 7 mm gap, 37dB over 10 mm gap
Standard lengths	708, 833, 958, 1,092, 1,208 mm (can be shortened : 125 mm)
Min/max lengths	235 mm / 1,958 mm
Accessories	5115

### COLOURS/ART.NO.

Silver-coloured, anod. (C-0)	1-875
Stainless steel-colored (C-31)	1-876

Surface mounted drop seals  
for hinged timber & metal doors

# Retrofit solutions for existing doors

Our range of surface mounted drop seals have been designed for use with existing doors that have been subjected to **new performance requirements**. Slimline, stylish design and concealed fixing points help maintain the door aesthetic where fully concealed drop seals cannot be fitted. For instances where time is a factor, clever installation features accommodate quick and easy installation.

The **seal drops automatically** when the door is closed to form a seal with the floor, retracting when the door is opened to ensure the door operation is unhindered. Their main purpose is to provide an effective barrier against sound transfer at the door threshold, as well as smoke, air, light, dirt, dust, insects and odours.



**Surface mounted drop seals**  
for hinged timber & metal doors

## Schall-Ex® L-15 FS

- / surface-mounted drop seal
- / parallel drop minimises friction with the floor
- / tool-free actuator can be deactivated before building occupancy
- / no lateral travel during actuation enhances gasket position
- / concealed screws and snap-on cover profile



### DIMENSIONS

Travel	20 mm
--------	-------

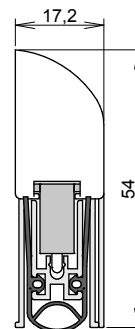

### TECHNICAL DATA

Application	hinged timber & metal doors
Actuation	single
Material	self-extinguishing, flame retardant silicone
Fixing	surface mounted to the face of the door, screw fixed
Performance	Fire: EN 1634-1, UL10B & UL10C (R31866) Smoke: Certifire TS21 (CF 5675) Acoustic: 51dB over 7 mm gap, 44dB over 12 mm gap
Standard lengths	805, 930, 1,055 mm (can be shortened : 125 mm)
Min/max lengths	235 mm / 1,600 mm
Accessories	5314

### COLOURS/ART.NO.

Silver-coloured, anod. (C-0)	1-884
Stainless steel-colored (C-31)	1-885
White (RAL 9016)	1-888

## Wind-Ex

- / surface-mounted drop seal
- / concealed screws and snap-on cover profile

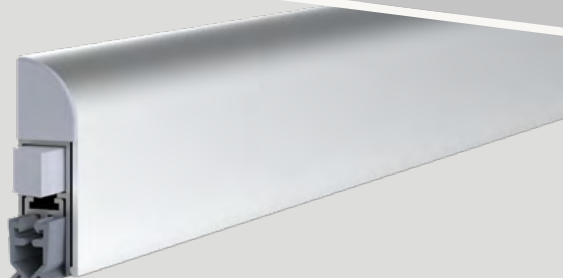

### DIMENSIONS

Travel	11 mm
--------	-------

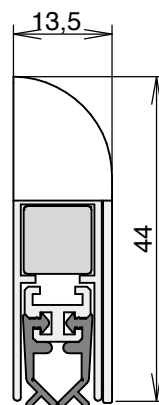

### TECHNICAL DATA

Application	hinged timber doors
Actuation	single
Material	PVC
Fixing	surface mounted to the face of the door, screw fixed
Standard lengths	735, 860, 958, 1,110 mm (Can be shortened : 125 mm)
Min/max lengths	235 mm / 1,335 mm
Accessories	5955

### COLOURS/ART.NO.

Silver-coloured, anod. (C-0)	1-310
Bronzel-colored (C-34)	1-309
White (RAL 9016)	1-311

### **UPGRADE EXISTING DOORS**

- / Improves the sound insulation and smoke control of existing doors

### **EASE OF INSTALLATION**

- / Install on existing doors without the need to dismantle the complete door system



# **NADI<sup>®</sup>**

## **RETROFIT SEALING SOLUTION**

### **SLIMLINE, DISCREET & STYLISH**

- / Slimline design and pre-finished features enable maximum architectural freedom and simple installation

### **FUTURE-PROOF & MAINTENANCE-FREE**

- / Uneven gaps caused by door warping can be overcome automatically, ensuring future technical performance

### **NATURALLY CERTIFIED**

- / Reference smoke testing in accordance with EN 1634-3 showcases suitability as a smoke seal for existing fire doors

### **BUDGET CERTAINTY**

- / Nadi® is priced & supplied per set, rather than per linear metre, offering maximum budget certainty



## Nadi® LM

## Nadi® FM

- / retrofit perimeter and meeting stile seal for reveal mounting
- / spring mechanism automatically adjusts up to 10mm to offset door warping (optionally 14mm)
- / Elongated holes, snap-on cover plate and pre-formed corners for easy installation
- / sets available for both single and double doors



DIMENSIONS	Nadi® LM	Nadi® FM
Tolerance compensation	10 mm (optionally 14 mm)	
Width & height, actuated	10,3 & 29 mm	25,4 & 18 mm
TECHNICAL DATA	Nadi® LM	Nadi® FM
Application	hinged timber & metal doors	
Material	self-extinguishing, flame retardant silicone	
Fixing	mounted to the frame on closing face, screw fixed	mounted to the frame reveal on closing face, screw fixed
Performance	Smoke: EN 1634-3	
Can be shortened	150 mm	

## SET COMPONENTS

/ Nadi® LM

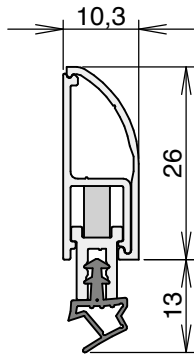

/ Nadi® FM

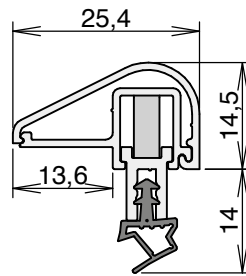

## LENGTHS/ART.NO.

	Nadi® LM set	Nadi® FM set		
Single-leaf door (mm)	H 2,100 x W 650 - 950	320 200	320 235	
	H 2,100 x W 951 - 1,250	320 201	320 236	
	H 2,100 x W 1,251 - 1,500	320 202	320 237	
	H 2,400 x W 650 - 950	320 208	320 238	
	H 2,400 x W 951 - 1,250	320 209	320 239	
	H 2,400 x W 1,251 - 1,500	320 210	320 240	
	H 2,700 x W 650 - 950	320 216	320 241	
	H 2,700 x W 951 - 1,250	320 217	320 242	
	H 2,700 x W 1,251 - 1,500	320 218	320 243	
	H 3,000 x W 650 - 950	320 225	320 244	
	H 3,000 x W 951 - 1,250	320 226	320 245	
	H 3,000 x W 1,251 - 1,500	320 227	320 246	
	Double-leaf door (mm)	H 2,100 x W 951-1,250	320 203	320 247
		H 2,100 x W 1,251 - 1,500	320 204	320 248
H 2,100 x W 1,501 - 1,800		320 205	320 249	
H 2,100 x W 1,801 - 2,100		320 206	320 250	
H 2,100 x W 2,101 - 2,400		320 207	320 251	
H 2,100 x W 2,401 - 2,700		320 316	-	
H 2,400 x W 951 - 1,250		320 211	320 252	
H 2,400 x W 1,251 - 1,500		320 212	320 253	
H 2,400 x W 1,501 - 1,800		320 213	320 254	
H 2,400 x W 1,801 - 2,100		320 214	320 255	
H 2,400 x W 2,101 - 2,400		320 215	320 256	
H 2,400 x W 2,401 - 2,700		320 317	-	
H 2,700 x W 951 - 1,250		320 219	320 257	
H 2,700 x W 1,251 - 1,500		320 220	320 258	
H 2,700 x W 1,501 - 1,800		320 221	320 259	
H 2,700 x W 1,801 - 2,100		320 222	320 260	
H 2,700 x W 2,101 - 2,400		320 223	320 261	
H 2,700 x W 2,401 - 2,700		320 224	320 262	
H 3,000 x W 951 - 1,250		320 228	320 263	
H 3,000 x W 1,251 - 1,500		320 229	320 264	
H 3,000 x W 1,501 - 1,800	320 230	320 265		
H 3,000 x W 1,801 - 2,100	320 231	320 266		
H 3,000 x W 2,101 - 2,400	320 232	320 267		
H 3,000 x W 2,401 - 2,700	320 233	320 268		
H 3,000 x W 2,701 - 3,000	320 234	320 269		

Further sets on request.

## Flush bolt

- / integrated flush bolt
- / continuous seal around bolt maintains optimal acoustic performance
- / machining of seal prepared by athmer before delivery
- / matching top and bottom versions available with same milling dimensions
- / compatible with Schall-Ex® L-15, Schall-Ex® Ultra and Stadi models



### DIMENSIONS

	for timber doors	for metal doors
Fitting tolerance range	8mm diameter bolt. 15mm throw, max. 10mm gap	
TK-15/T	250 mm	250 mm
TK-20/B-SU	266 mm	-
TK-15/BXL	276 mm	-
TK-20 II	-	274 mm

### TECHNICAL DATA

Application	hinged doors
Material	stainless steel
Fixing	rebated into a groove in the door, screw fixed

### ART.NO.

TK-15/T	1653
TK-20/B-SU	1652-2
TK-15/BXL	1792
TK-20 II	1651

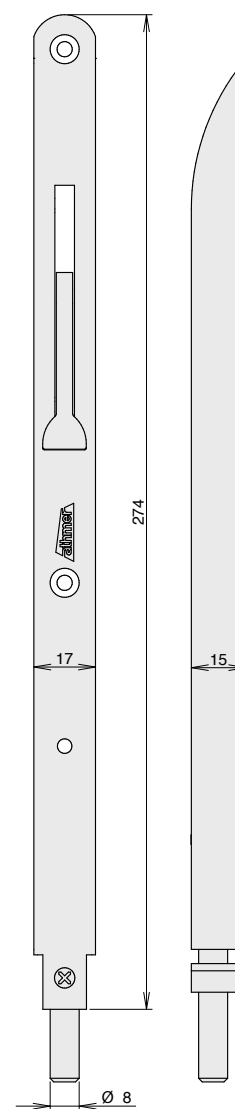

## Concealed flush bolt

- / integrated concealed flush bolt
- / continuous seal around bolt maintains optimal acoustic performance
- / machining of seal prepared by athmer before delivery
- / fully concealed unit, ideal for automatic & panic systems
- / M6 & M10 bolt connection options
- / compatible with Schall-Ex® L-15, Schall-Ex® Ultra and Stadi models



### DIMENSIONS/ART.NO. for timber doors for metal doors

Fitting tolerance range 8mm diameter bolt. 15mm throw, max. 10mm gap

1502-1187	M6, 1,187 mm	M6, 1,187 mm
1502-1217	M10, 1,217 mm	M10, 1,217 mm
1502-1487	M6, 1,487 mm	M6, 1,487 mm
1502-1517	M10, 1,517 mm	M10, 1,517 mm

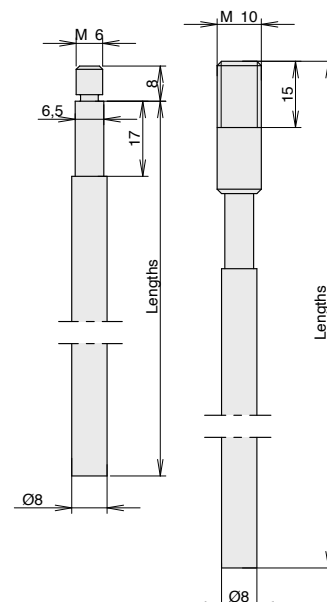

### TECHNICAL DATA

Application	hinged doors
Material	stainless steel
Fixing	rebated into a groove in the door, screw fixed

## Threshold plates

# Performance without restriction

Our range of aluminium and stainless steel threshold plates provide a **stylish connection between** two rooms or spaces, covering the gap between different floor types and thicknesses. The range can be supplied with or without pre-drilled holes, providing the option for a more practical, screwed installation or a more aesthetic, screw-free installation with adhesive.

Threshold plates provide an optimal sealing surface for our drop seals to seal against. The majority of the range is low-profile, designed with a focus on minimising impact on movement through a building. Our range also consists of certified **barrier-free solutions** to cater to recent construction trends and the rapidly growing sector of barrier-free living.



## Threshold plates

## Thresholds

- / recommended for optimal acoustic performance
- / range of options for use with both carpets and tiled floors
- / low profile, suitable for disabled access
- / stainless steel (Niro) or aluminium (Alu) profiles supplied with protective film

TECHNICAL DATA	Niro	Alu
Application	at the threshold of doorsets	
Material	stainless steel	aluminium
Fixing	bonded with adhesive or fixed with screws (not supplied)	

ART.NO.	Niro 164	Niro 365	Niro 288	Niro 513
	3-107	3-135	3-103	3-150
	Alu 090	Alu 253	Alu 088	Alu 277
	3-111	3-114	3-117	3-104
	Alu 308	Alu 278	Alu 217	Alu 496
	3-120	3-108	3-100	3-152

**DIMENSIONS**

**Niro 164**

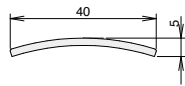

**Niro 365**

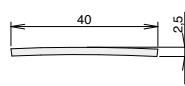

**Niro 288**

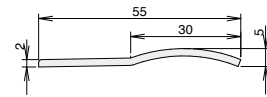

**Niro 513**

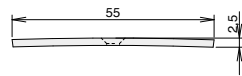

**Alu 090**

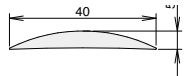

**Alu 253**

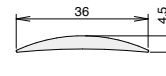

**Alu 088**

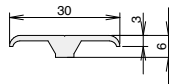

**Alu 277**

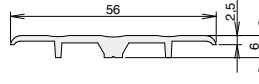

**Alu 308**

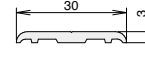

**Alu 278**

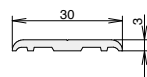

**Alu 217**

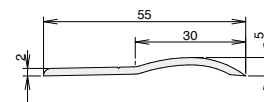

**Alu 496**

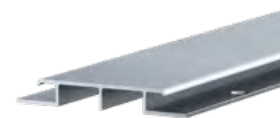
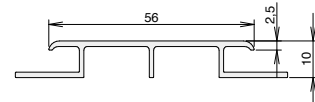

CHOOSE YOUR  
**PRODUCT**

# Cross section drawings

## REBATED DROP SEALS FOR HINGED & PIVOTED TIMBER DOORS

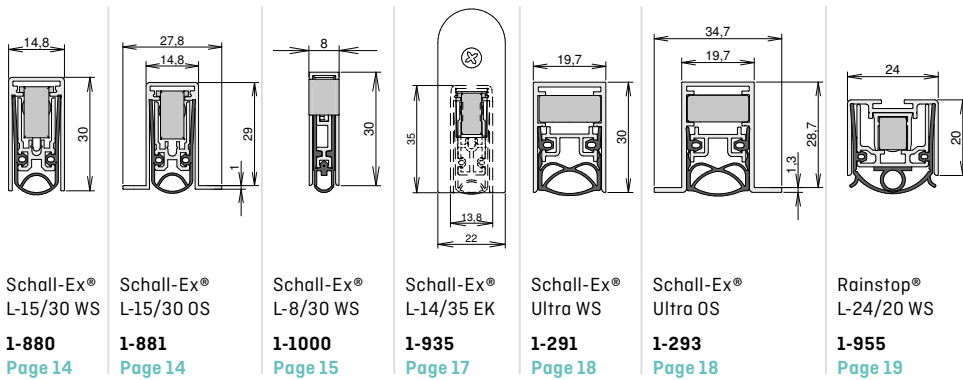

## REBATED DROP SEALS FOR HINGED SYSTEM DOORS

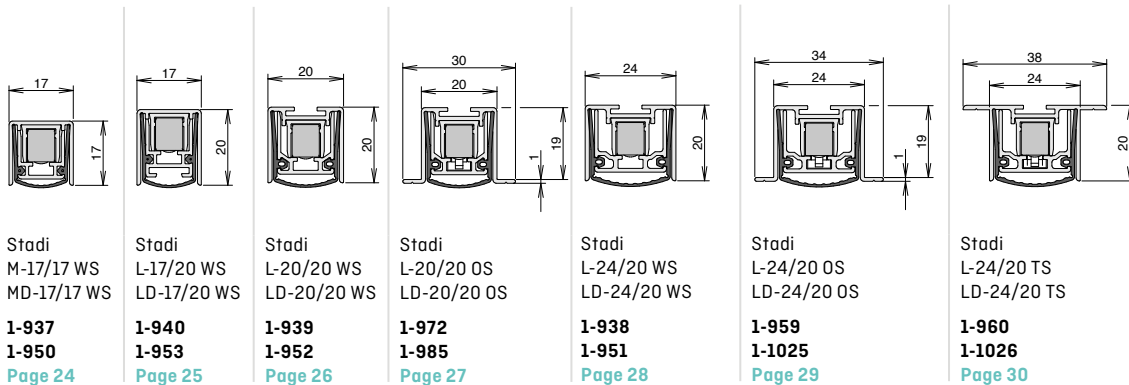

## DROP SEALS FOR HINGED GLASS DOORS

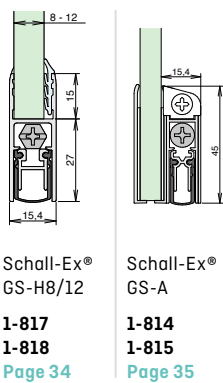

## DROP SEALS FOR SLIDING TIMBER, METAL & GLASS DOORS

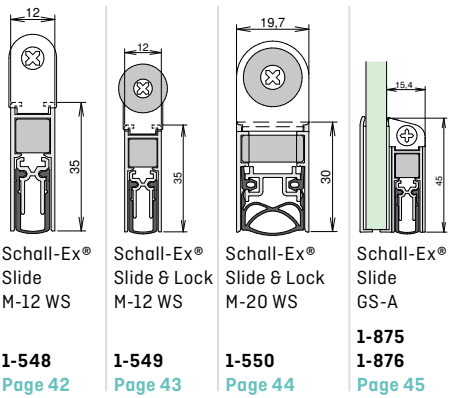

## SURFACE MOUNTED DROP SEALS FOR HINGED TIMBER & METAL DOORS

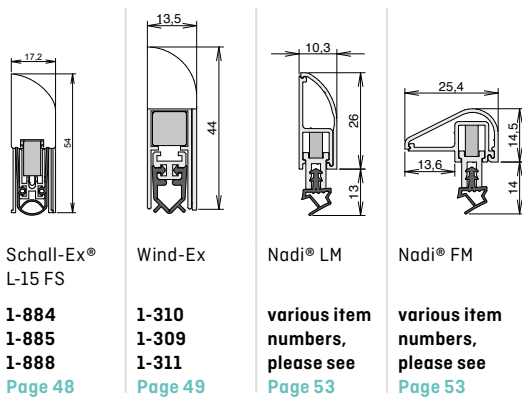

## THRESHOLD PLATES

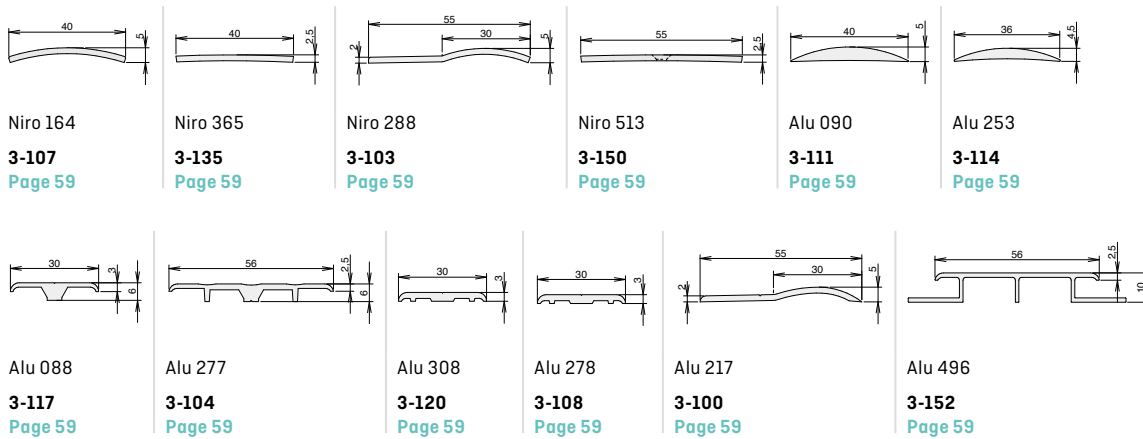



# Installation information

## AUTOMATIC DROP SEALS

### HINGED TIMBER, SYSTEM & GLASS DOORS

- / Fixing: in the groove
  - single actuation, hinge side
  - double actuation, hinge & lock side
  - single actuation, lock side

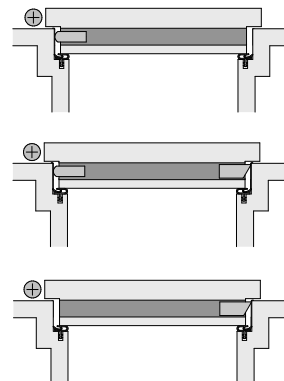

- / Fixing: surface mounted
  - single actuation, hinge side
  - single actuation, hinge side with angle pressure bracket
  - single actuation, hinge side

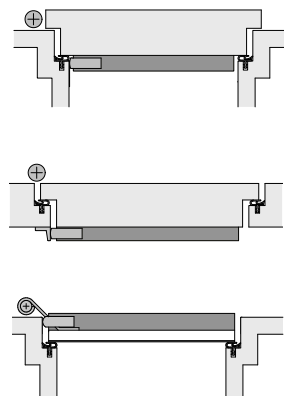

- / Fixing: bonded to underside
  - single actuation, hinge side
  - double actuation, hinge & lock side

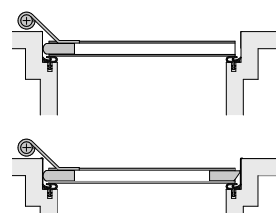

### SLIDING TIMBER, SYSTEM & GLASS DOORS

- / Fixing: in the groove
  - single actuation, lock side

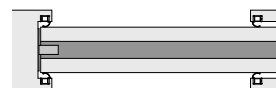

- / Fixing: surface mounted
  - single actuation, lock side



- / Fixing: bonded to underside
  - single actuation, lock side



# Glossary of terms

## AUTOMATIC DROP SEALS

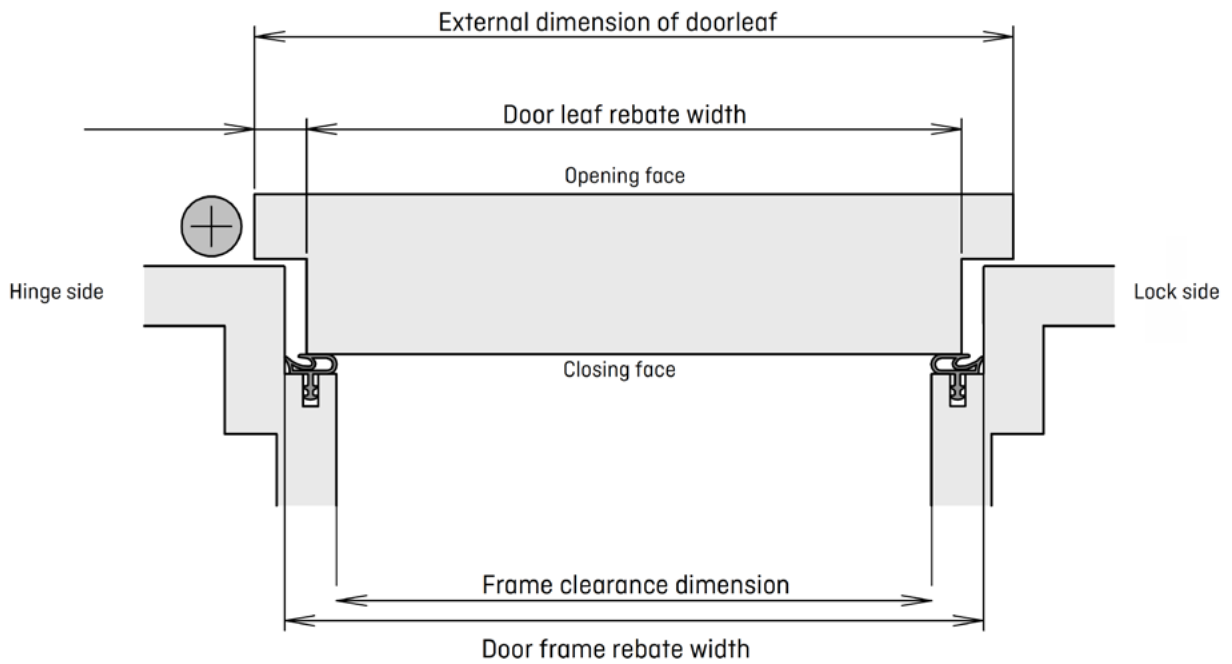

## PRODUCT NAMES

e.g. Schall-Ex® L-15/30 WS

TRAVEL	GROOVE DIMENSION (MM)	FIXING
M- medium travel	15 - groove width	EK - end caps
L- large travel	30 - groove depth	WS - fixing brackets
MD- medium travel, delayed drop		OS - omega-shaped profile (screw under)
LD- large travel, delayed drop		TS - T-shaped profile (screw under)
		FS - surface mounted

# Glossary of terms

## **ACTUATION**

The motion a drop seal makes when it's sealing profile drops to the floor.

## **ACTUATOR**

Drop seal component that protrudes from one or both sides of a door and is compressed by contact with the door frame. Upon compression it activates the inner rail and sealing profile, pushing them towards the floor.

## **AUTOMATIC DROP SEAL**

An item of door hardware located at the bottom of a door, typically made from aluminium with built-in spring mechanism. It contains a sealing profile gasket typically made from silicone, which drops automatically upon door closing to form a seal with the floor by sealing the gap at the bottom and retracts upon door opening.

## **BACKSET**

An ironmongery term to describe the distance between the door edge and the specified part of a door hardware item, e.g. the centre of the bolt on a flush bolt or the centre of the spindle on a door lock.

## **DELAYED DROP**

An athmer technology available with selected drop seals. It delays actuation of the seal for 6-8 seconds after the door closes. A delay in actuation will prevent pressure changes from affecting the door operation. This feature is particularly useful in positive-pressure environments, a growing application in hospitals and biosafety labs

## **DOUBLE ACTUATION**

An athmer technology available with selected drop seals. These models have an additional actuator on the latch side of the door, spreading actuation pressure more evenly over the door. This feature is particularly useful with wide doors and supports long-term durability.

## **FIRE DOOR**

An engineered life safety device. Fire door is a term often used to describe a full fire door assembly including the door leaf, frame and essential hardware, which has been designed to resist fire for a specific period of time.

## **HEAD & JAMBS**

The two types of component that together make up a door frame. The jambs are vertical members positioned at each side of a door opening. The head is a horizontal member positioned at the top of a door opening.

## **INNER RAIL**

Drop seal component used to hold the sealing profile typically made from aluminium. It is contained within the main outer housing and drops to the floor during seal actuation.

## **MEETING STILE**

The gap where a pair of doors meet.

## **OVERLOAD PROTECTION**

An athmer technology present in selected drop seals that automatically detects when the sealing profile has dropped far enough and cuts off further actuation pressure. Overload protection ensures a consistent, even seal and protects the seal's components from excessive pressure.

## **PARALLEL DROP**

An athmer technology incorporated in selected drop seals that drops the sealing profile evenly on both sides of the door. Parallel drop prevents seal dragging and supports long-term durability.

**PRESS PLATE**

A thin metal plate often supplied with our drop seals, used to prevent damage to door frames. They are supplied as an accessory to our drop seals.

**PVC (POLYVINYL CHLORIDE)**

A synthetic plastic polymer that can be extruded in both rigid and flexible forms for a variety of uses.

**SELF-EXTINGUISHING, FLAME-RETARDANT SILICONE**

A type of elastomer (rubber) containing silicone, which when set alight will extinguish flames by itself. Standards available to test the performance of this type of material include UL 94.

**SLIDING ACTUATOR**

A particular type of actuator developed by athmer and made from a technical nylon material, designed to 'slide' across door frame surfaces. This type of actuator reduces friction with the door frame, protecting both the actuator and door frame from long-term wear.

**TPE (THERMOPLASTIC ELASTOMER)**

A type of copolymer (usually a mix of plastic and rubber) that consists of materials with both thermoplastic and elastomeric properties.

**WORKING TEMPERATURE**

The temperature range within which a seal will function correctly and as described. Sometimes referred to as operating temperature.

# Standards

## **BS 476-22**

Method for determination of the fire resistance of non-loadbearing elements of construction (British standard)

## **DIN 18095-2**

Type testing for durability and leakage of smoke control doors

## **DIN 4102-18**

Fire behaviour of building materials and components; fire barriers, verification of automatic closure (continuous performance test)

## **EN 1026**

Test method – air permeability of windows and doors

## **EN 1027**

Test method – water tightness of windows and doors

## **EN 1191**

Test method for resistance to repeated opening and closing of windows and doors

## **EN 12207**

Classification – air permeability of windows and doors

## **EN 12208**

Classification – water tightness of windows and doors

## **EN 12210**

Classification – resistance to wind load of windows and doors

## **EN 16005**

Requirements and test methods for power operated pedestrian doorsets

## **EN 1628**

Test method – determination of resistance under static loading of pedestrian doorsets, windows, curtain walling, grilles and shutters

## **EN 1629**

Test method – determination of resistance under dynamic loading of pedestrian doorsets, windows, curtain walling, grilles and shutters

## **EN 1630**

Test method – determination of resistance to manual burglary attempts of pedestrian doorsets, windows, curtain walling, grilles and shutters

## **EN 1634-1**

Fire resistance test for door and shutter assemblies, openable windows and elements of building hardware.

\*The test value may differ according to the EN 1634-1 test, as the complete door system must be checked.

## **EN 1634-3**

Smoke control test for door and shutter assemblies, openable windows and elements of building hardware

## **EN 1670**

Requirements and test methods for corrosion resistance of building hardware

**DIN 18040-1**

Design principles for construction of accessible buildings – publicly accessible buildings

**DIN 18040-2**

Design principles for construction of accessible buildings – dwellings

**DIN 18040-3**

Design principles for construction of accessible buildings – public circulation areas and open spaces

**EN ISO 717-1**

Rating of sound insulation in buildings and of building elements – airborne sound insulation

**EN ISO 10140-1**

Laboratory measurement of sound insulation of building elements – application rules for specific products

**EN ISO 10140-2**

Laboratory measurement of sound insulation of building elements – measurement of airborne sound insulation

**EN ISO 10140-3**

Laboratory measurement of sound insulation of building elements – measurement of impact sound insulation

**EN ISO 10140-4**

Laboratory measurement of sound insulation of building elements – measurement procedures and requirements

**EN ISO 10140-5**

Laboratory measurement of sound insulation of building elements – requirements for test facilities and equipment

# Index

Product	Page	Product	Page
<b>A</b>		Schall-Ex® L-15/30 WS	14
Alu 088	58	Schall-Ex® Slide M-12 WS	42
Alu 090	58	Schall-Ex® Slide & Lock M-12 WS	43
Alu 217	58	Schall-Ex® Slide & Lock M-20 WS	44
Alu 253	58	Schall-Ex® Slide GS-A	45
Alu 277	58	Schall-Ex® Ultra OS	18
Alu 278	58	Schall-Ex® Ultra WS	18
Alu 308	58	Stadi L-17/20 WS	25
Alu 496	58	Stadi L-20/20 OS	27
<b>C</b>		Stadi L-20/20 WS	26
Concealed flush bolt	55	Stadi L-24/20 OS	29
<b>F</b>		Stadi L-24/20 TS	30
Flush bolt	54	Stadi L-24/20 WS	28
<b>N</b>		Stadi LD-17/20 WS	25
Nadi® FM	52	Stadi LD-20/20 OS	27
Nadi® LM	52	Stadi LD-20/20 WS	26
Niro 164	58	Stadi LD-24/20 OS	29
Niro 288	58	Stadi LD-24/20 TS	30
Niro 365	58	Stadi LD-24/20 WS	28
Niro 513	58	Stadi M-17/17 WS	24
<b>P</b>		Stadi MD-17/17 WS	24
Pivot L-15 (set)	38	<b>V</b>	
<b>R</b>		VHH M-12 (set)	40
Rainstop® L-24/20 WS	19	<b>W</b>	
<b>S</b>		Wind-Ex	49
Schall-Ex® GS-A	35		
Schall-Ex® GS-H8/12	34		
Schall-Ex® L-8/30 WS	15		
Schall-Ex® L-14/35 EK	17		
Schall-Ex® L-15 FS	48		
Schall-Ex® L-15/30 OS	14		



**athmer oHG**  
Headquarter  
Sophienhammer  
59757 Arnsberg-Müschede  
Germany  
T +49 2932 477 500  
**info@athmer.com**

**athmer**